

Terrein CAN /CAR Saintes 24, 25 é 26 août 2018

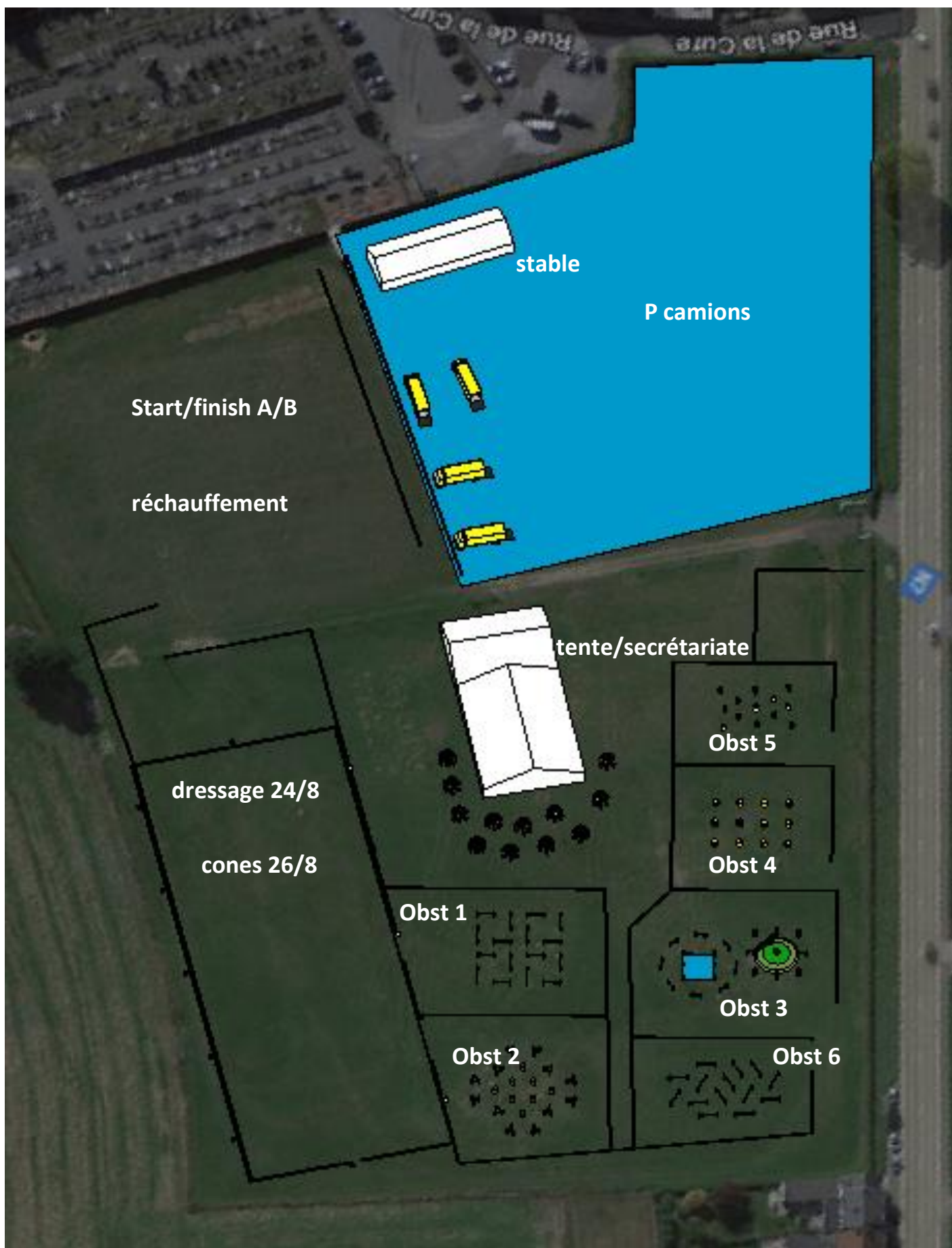



Saintes 2018

Obstacle 1

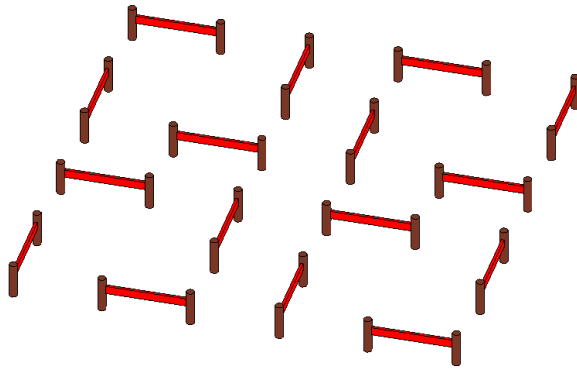

CAN** A > F

CAN* A > E

CAR A > E

Jong A > E

3 x Knock Down ★

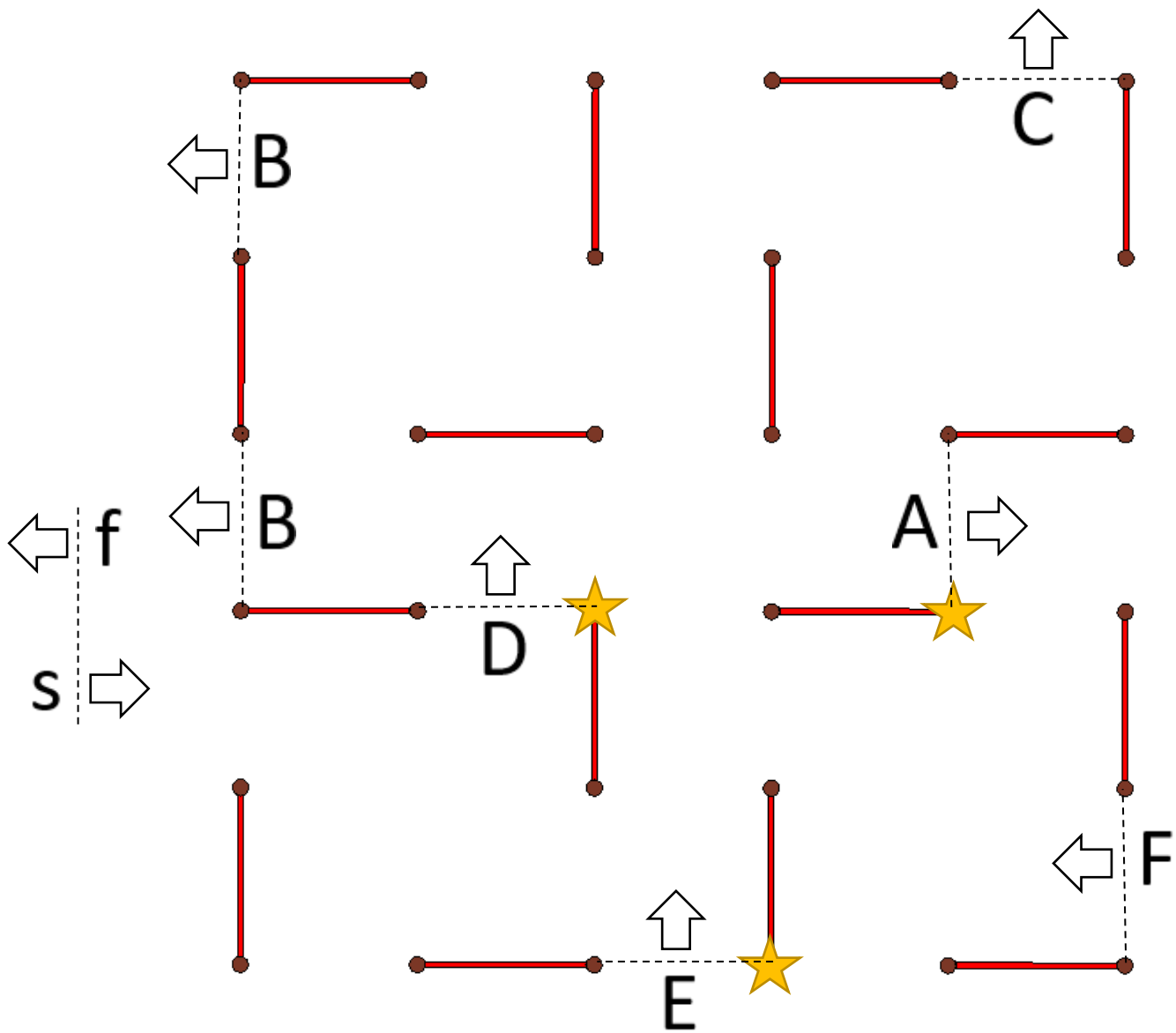



Saintes 2018

Obstacle 2

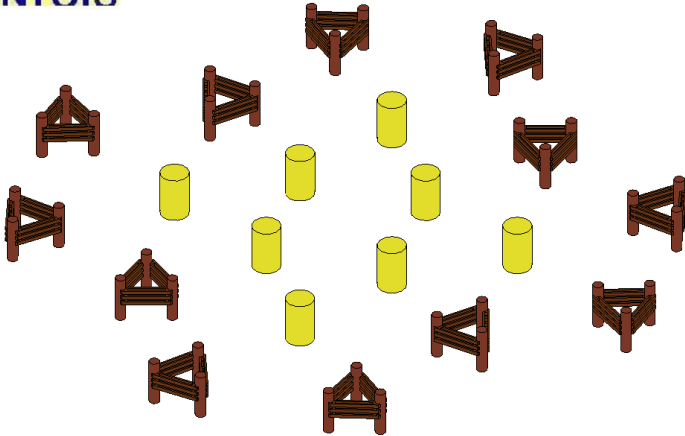

CAN** A > F

CAN* A > E

CAR A > E

Jong A > E

2 x Knock Down ★

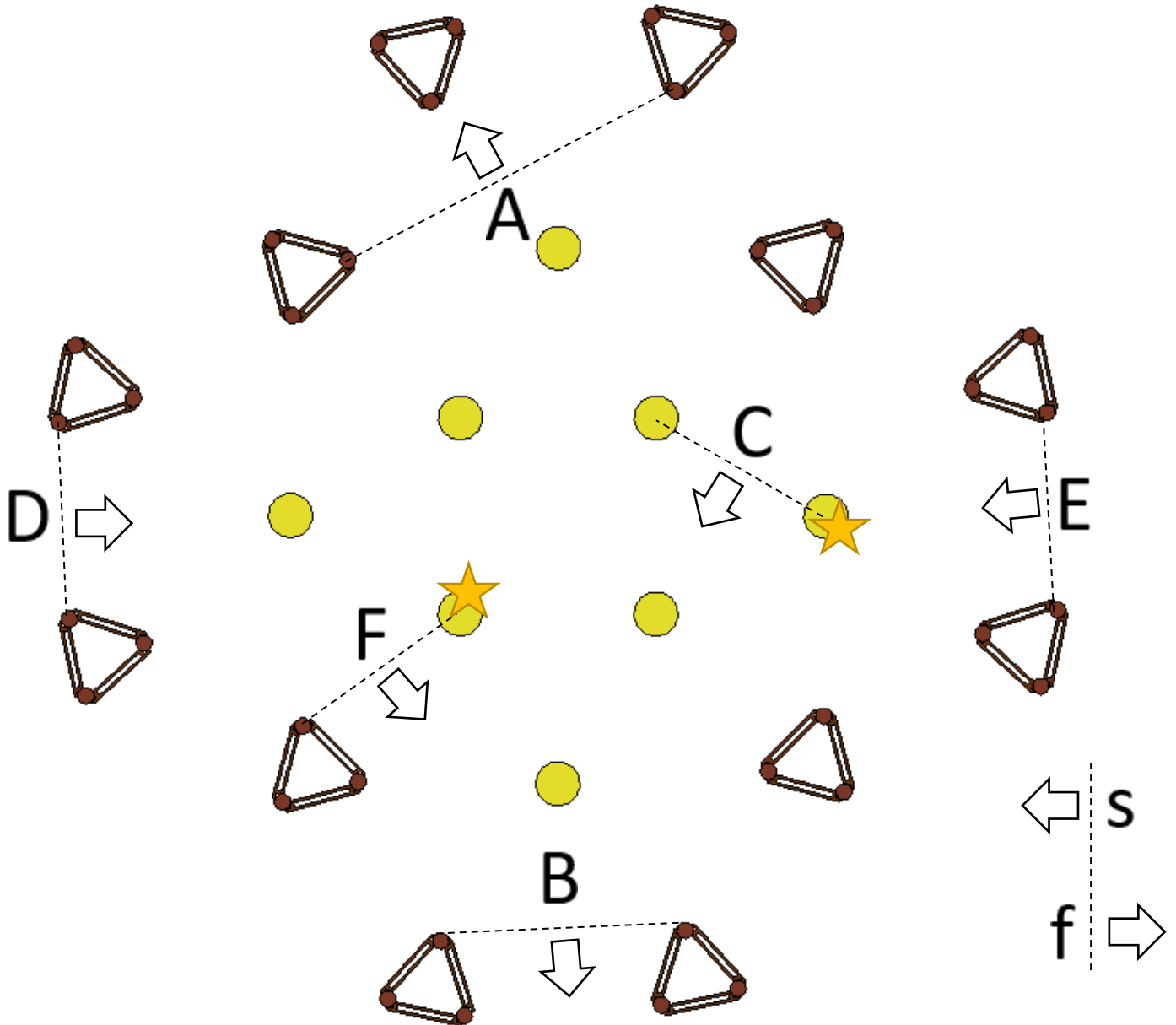



Saintes 2018

Obstacle 3

CAN** A > F

CAN* A > E

CAR A > E

Jong A > E

2 x Knock Down ★

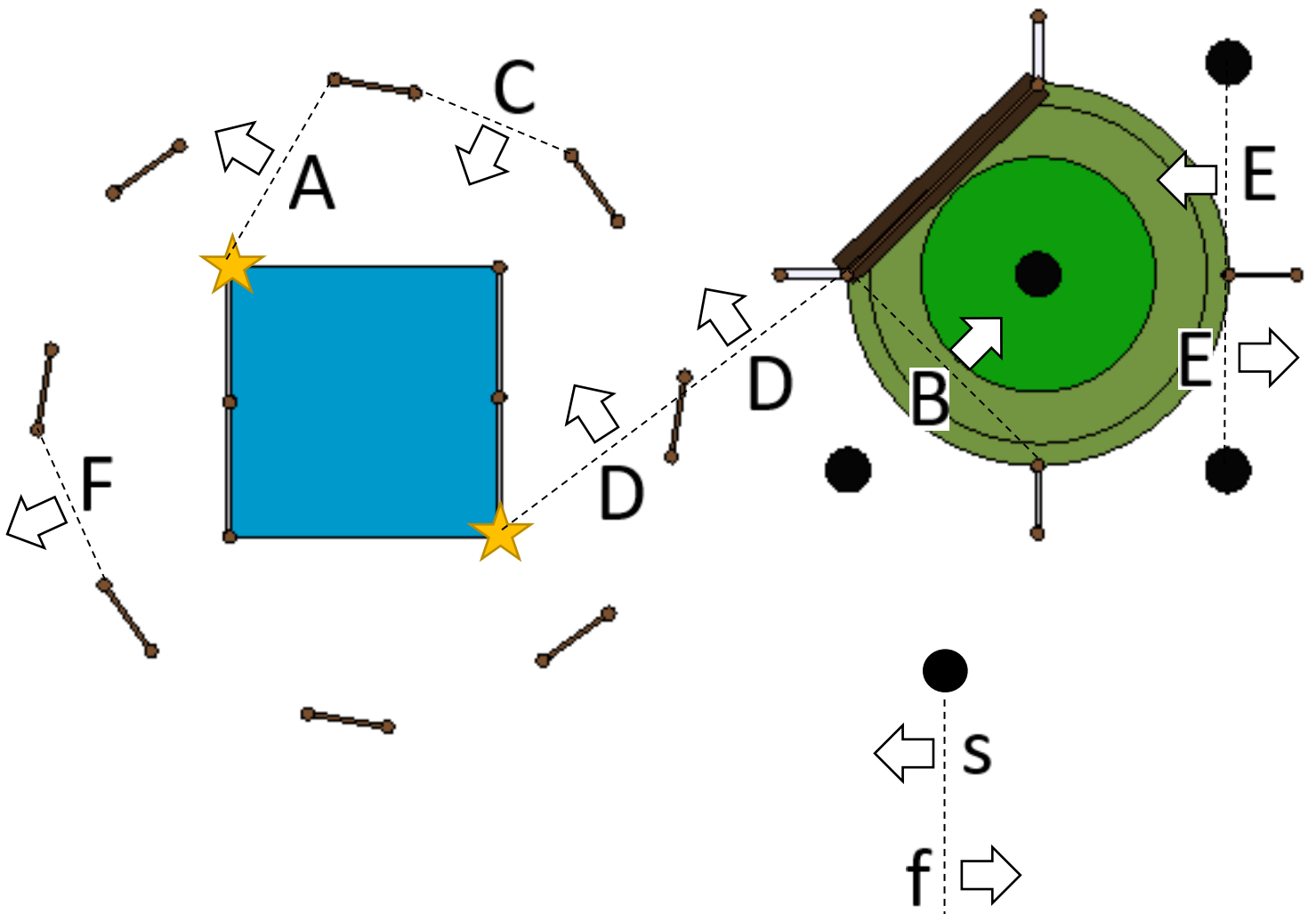
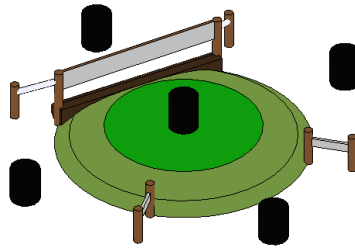
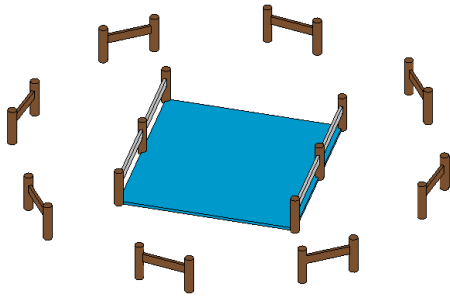



Saintes 2018

Obstacle 4

CAN** A > F

CAN* A > E

CAR XXXX

Jong A > E

4 x Knock Down ★

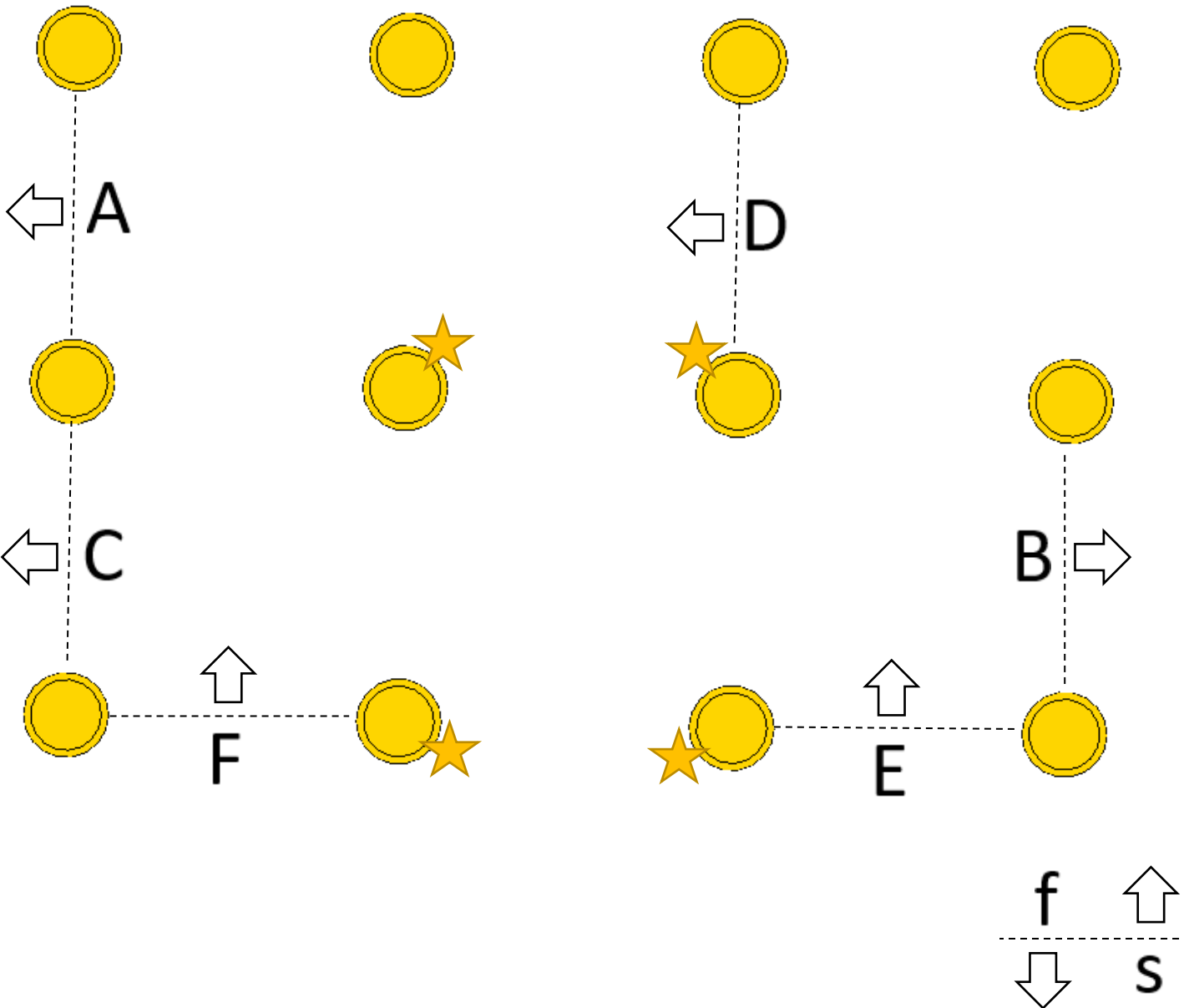
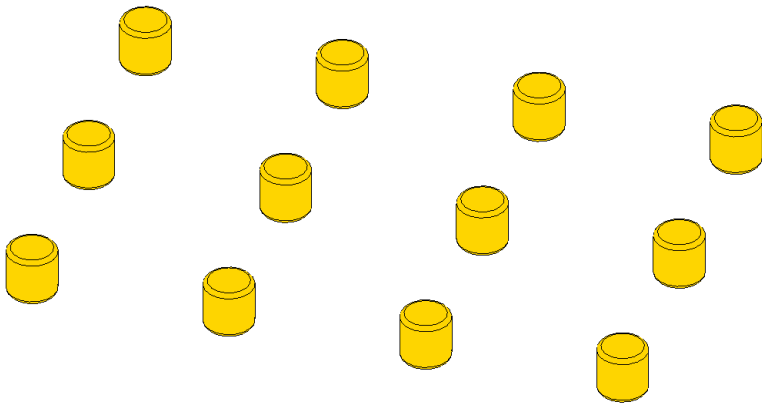



Saintes 2018

Obstacle 5

CAN** A > F

CAN* XXXX

CAR XXXX

Jong XXXX

6 x Knock Down 

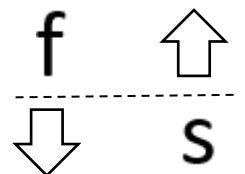
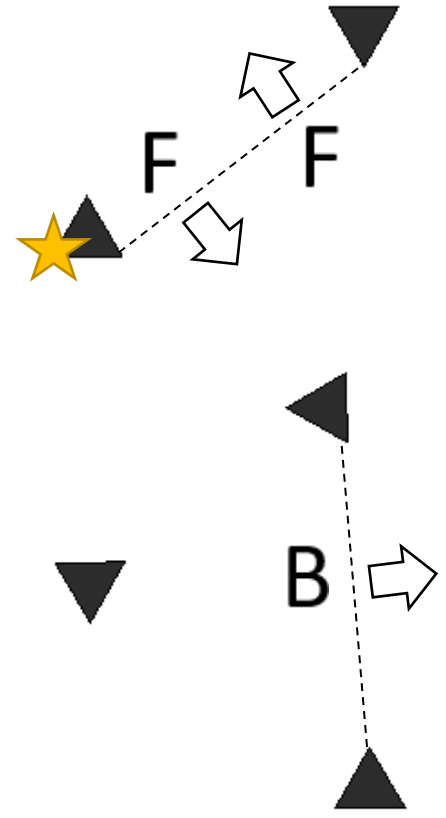
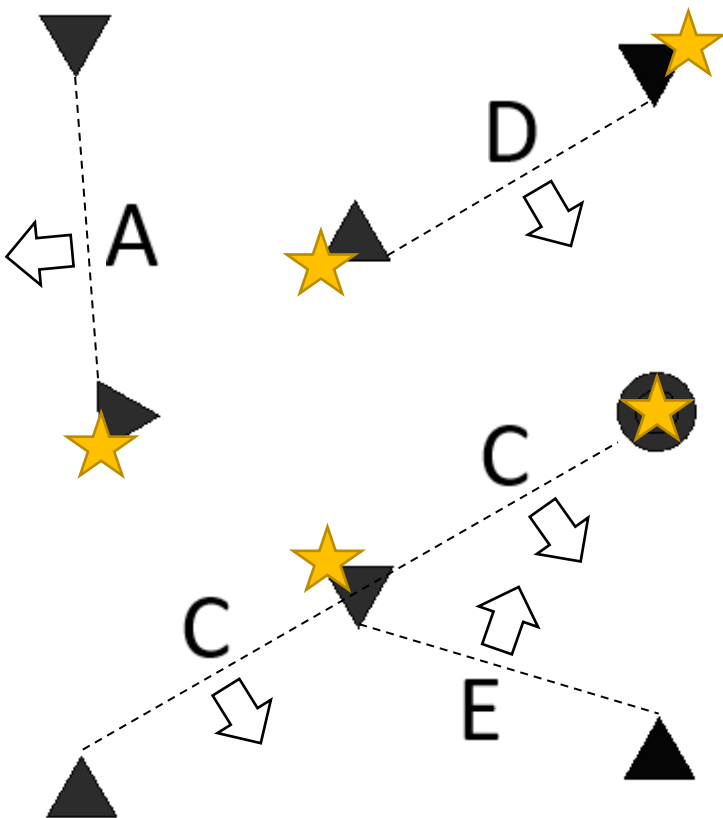
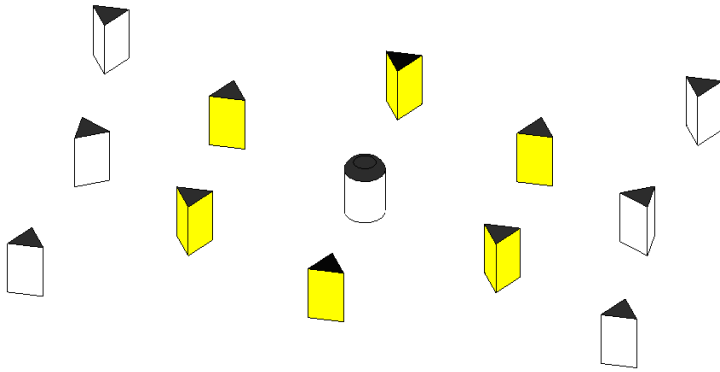



Saintes 2018

Obstacle 6

CAN** A > F

CAN* A > E

CAR A > E

Jong A > E

3 x Knock Down ★

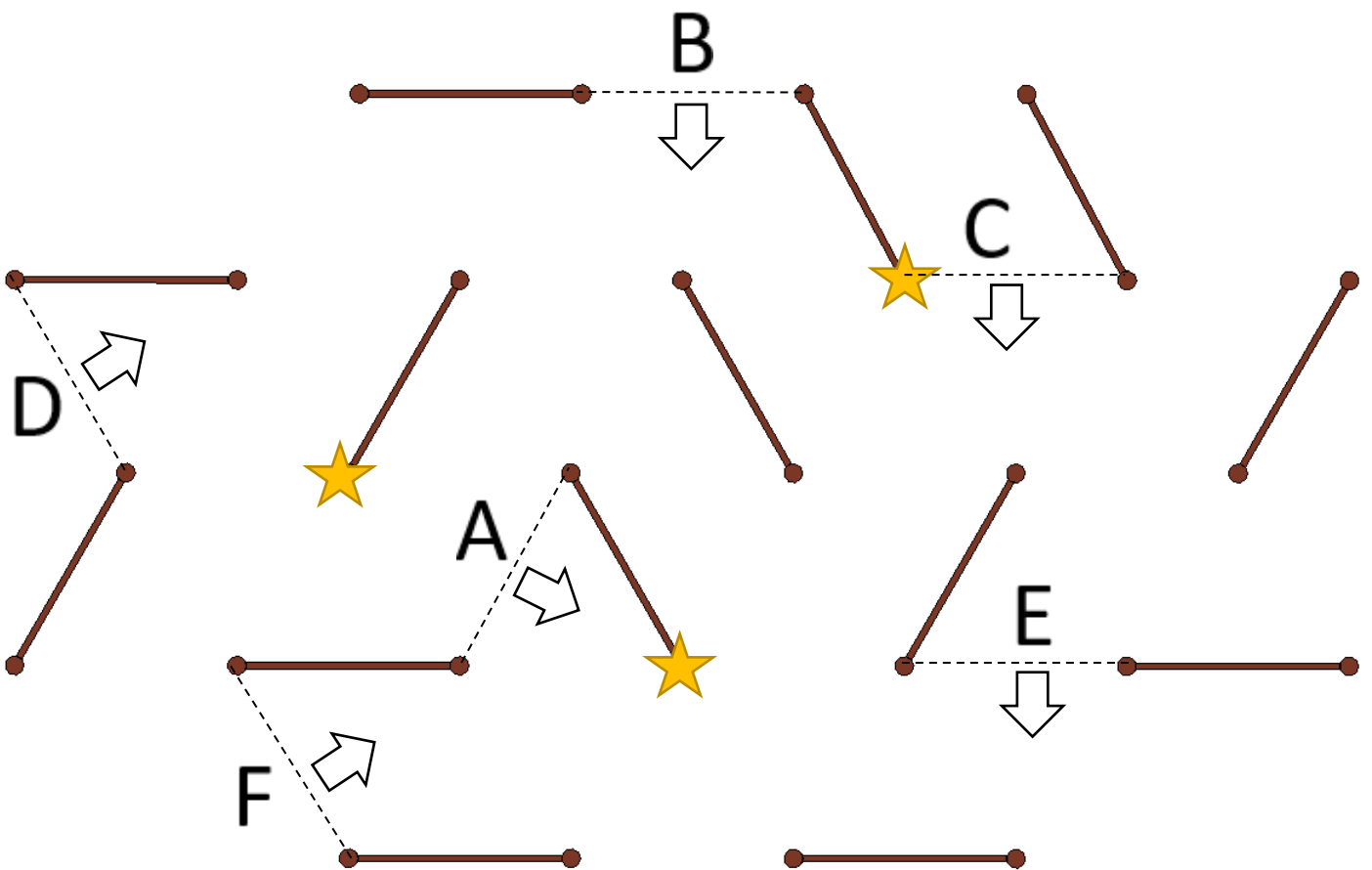
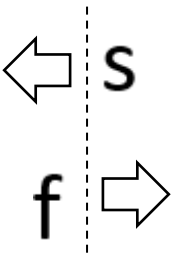
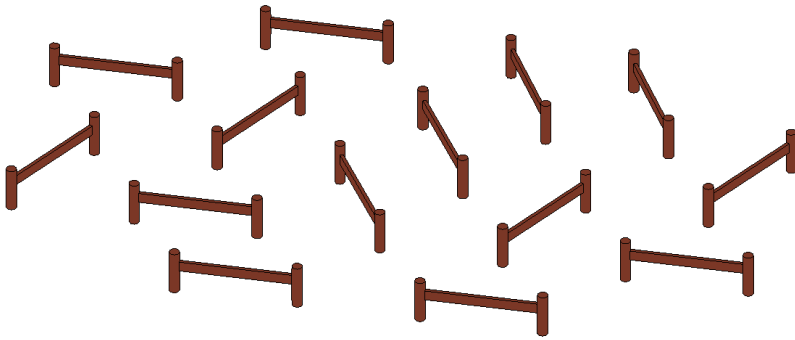



Phazes Marathon Saintes 25 août 2018

CAN start A, km1, km2, po1, km3, km4, po2, km5, km6, km7, po3, 300m, finish B =m

CAR start A, km1, km2, po1, km3, po2, km4, 300m, finish B =m



CAN**: start B, po1, po2, po3, O1, po4, po5, O2, po6, po7, O3 po8, po9, O4, po10, po11, O5, po12, po13 O6, Finish B =m

CAN*: start B, po1, po2, po3, O1, po4, po5, O2, po6, po7, O3, po8, po9, O4, po10, po11, O6, finish B =m

CAR : start B, po1, po2, po3, O1, po4, po5, O2, po6, po7, O3, po8, po9, O6, finish B =m

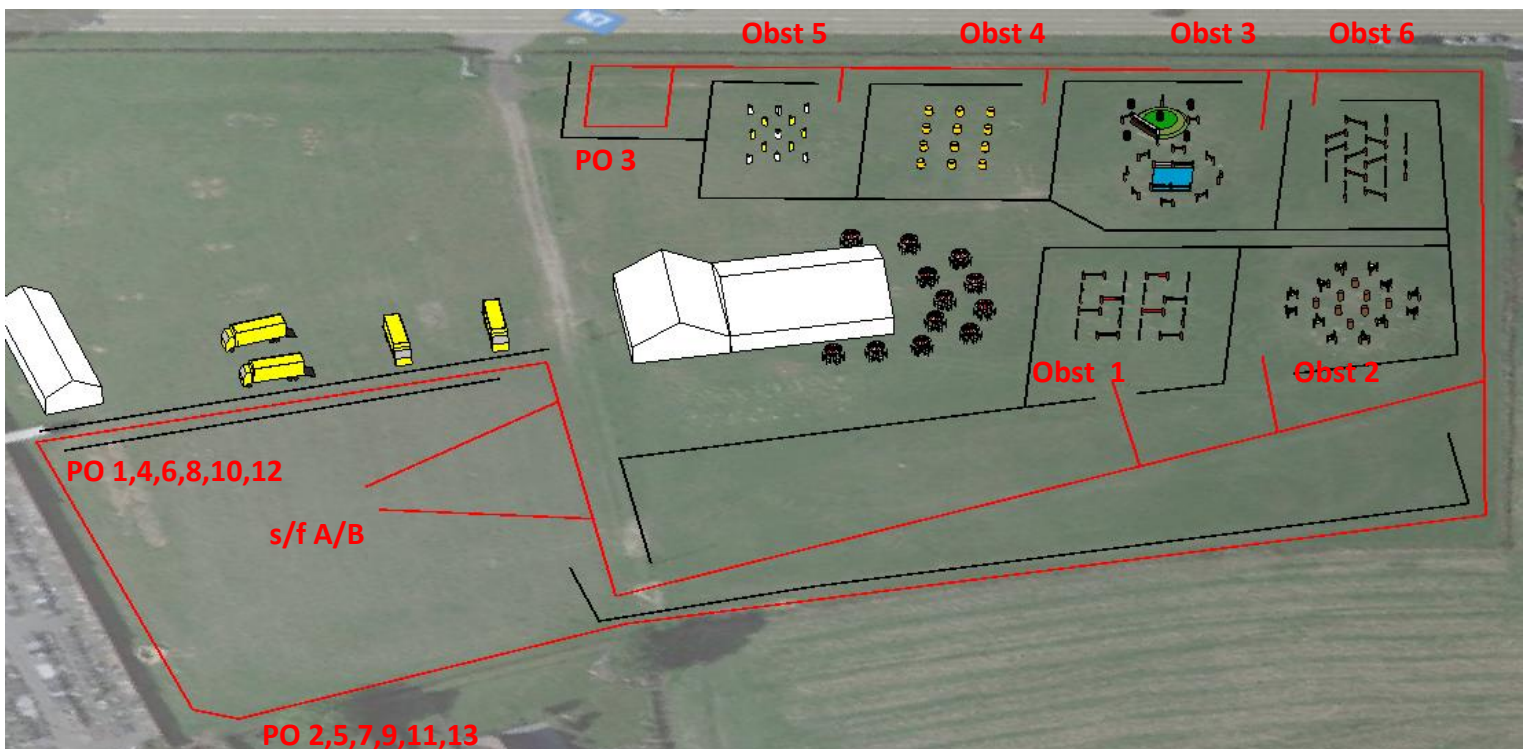

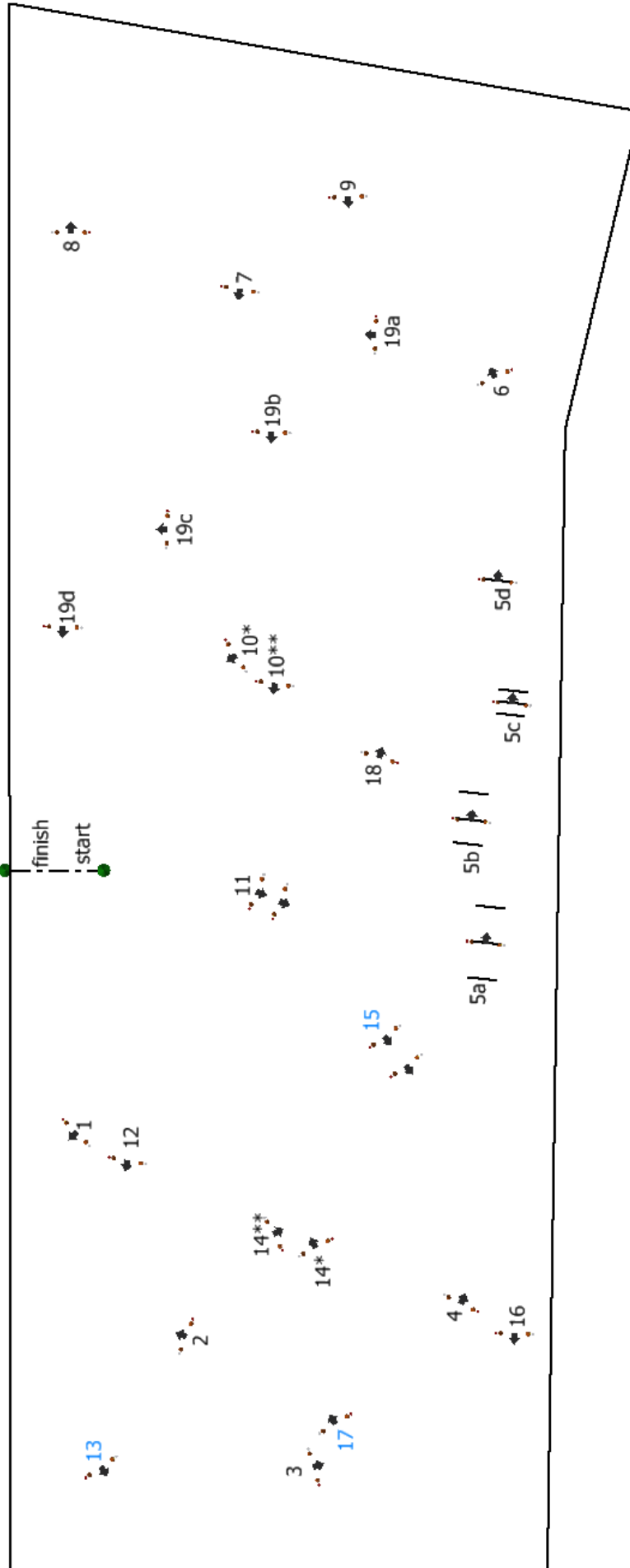

CAR

1,2,3,4,5,6,7,8,9,10*,
11,12,13,14*,18,19d

5abcd > 1po,2po > 9m

5abcd > 1ch,4po > 10m

5abcd > 2ch,4ch > 11m

19abcd > toutes les
catégories > 10m