

CAN BOOISCHOT 2016

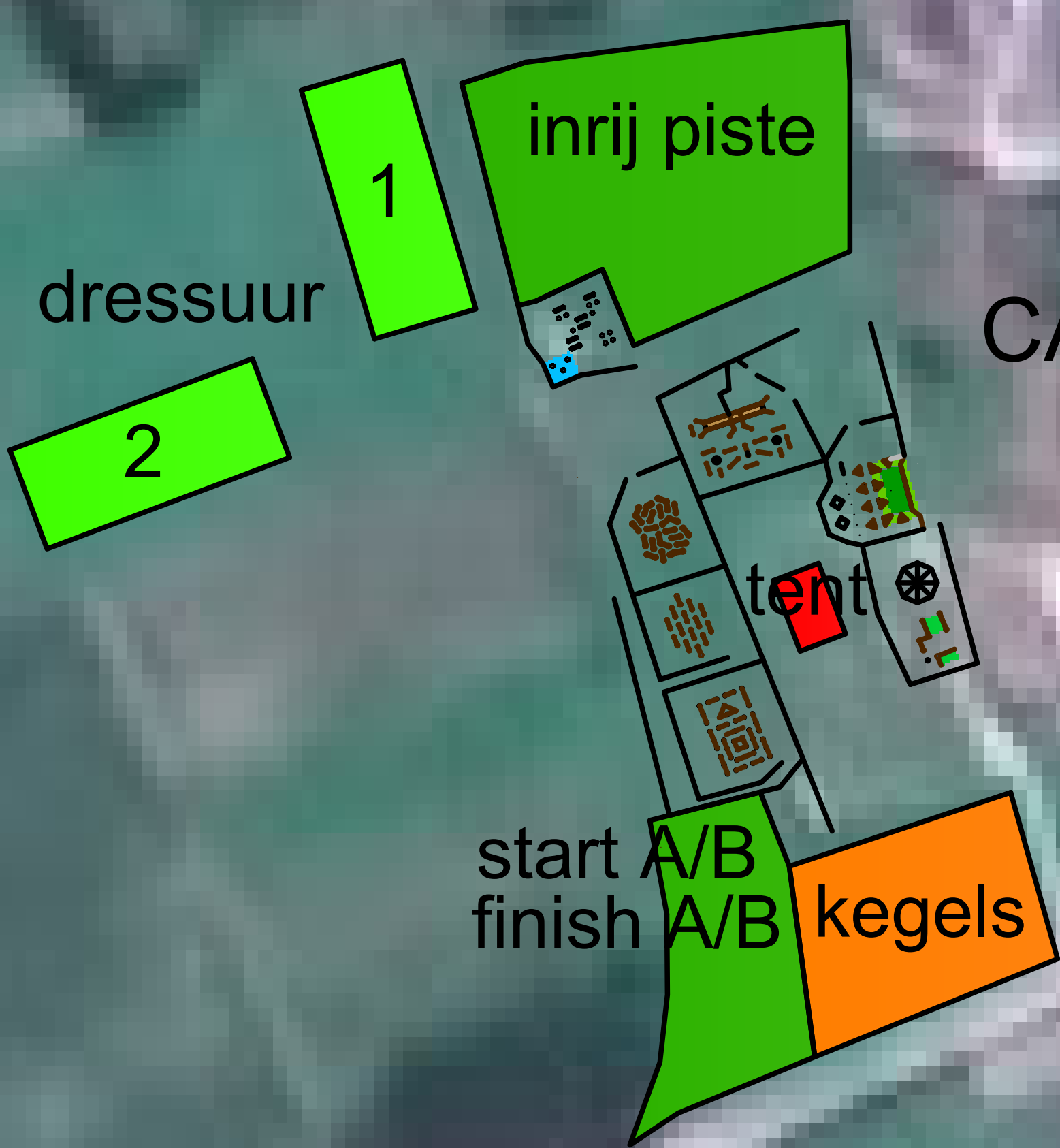

parking
→
stallen

CAN BOOISCHOT 2016

Hindernis 1

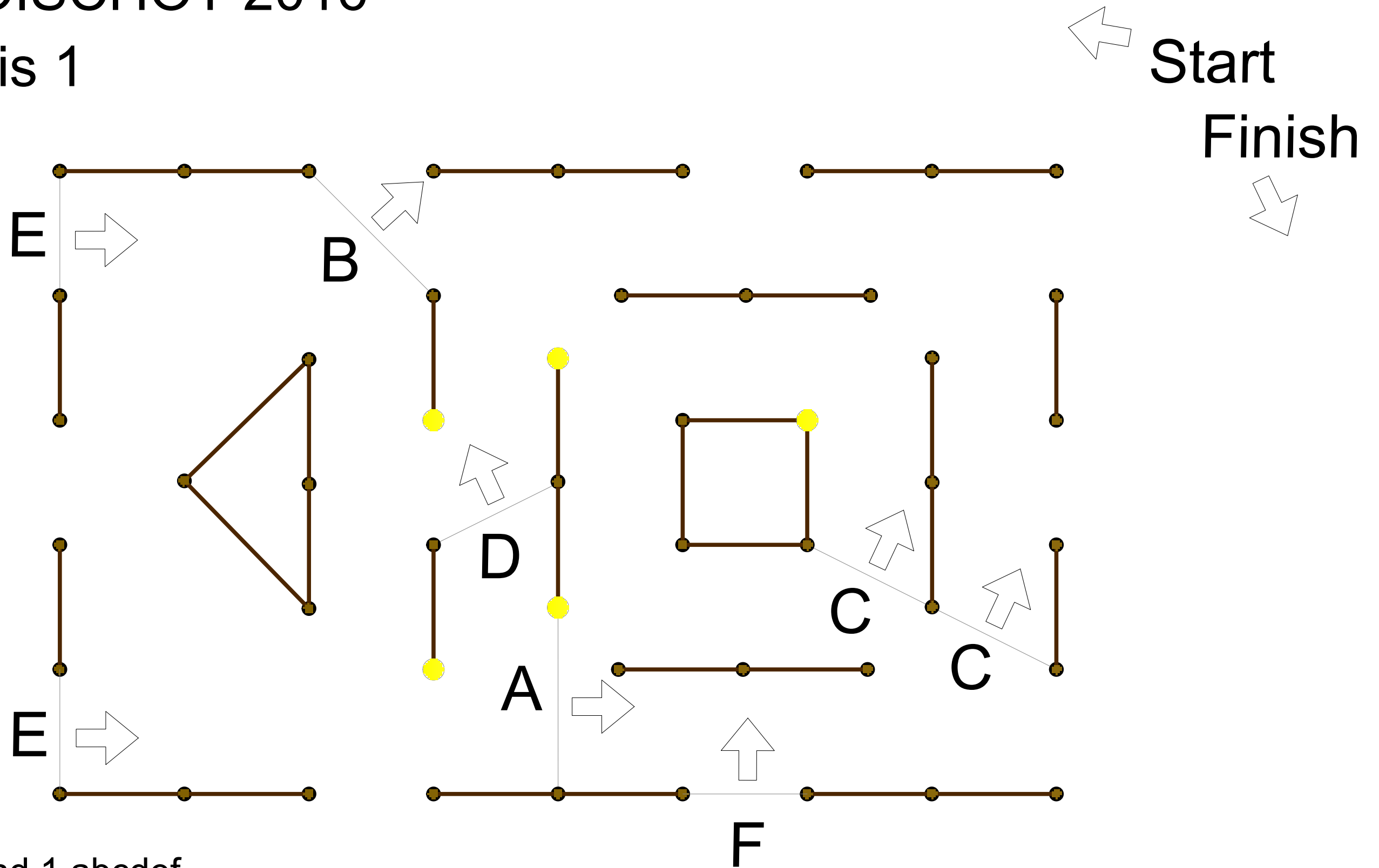

CAN ** Hind 1 abcdef
CAN * Hind 1 abcde

● 5 X knock down



CAN BOOISCHOT 2016

Hindernis 2

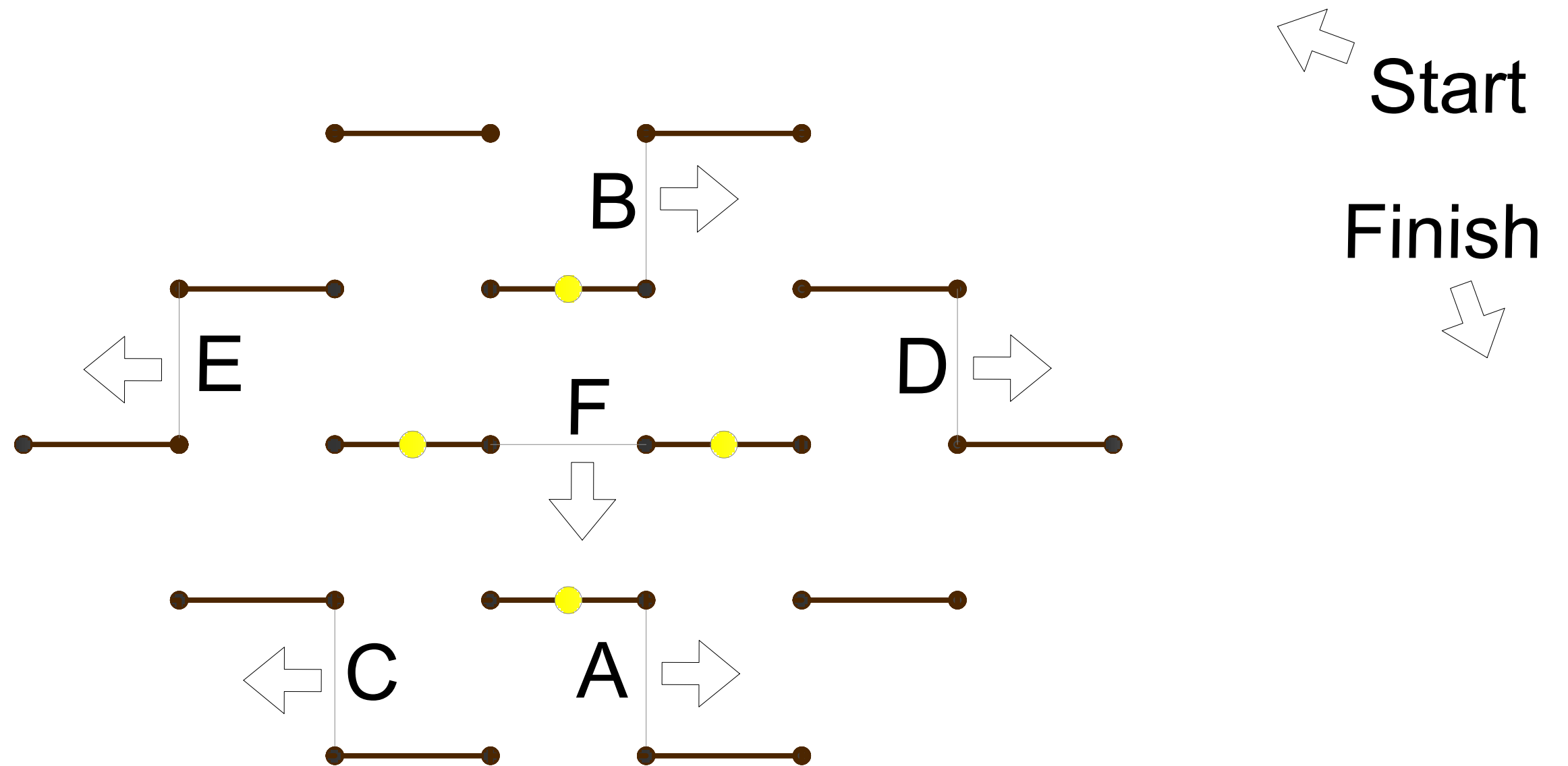

CAN ** Hind 2 abcdef
jun & ch Hind 2 abcde

● 4 X knock down



CAN BOOISCHOT 2016

Hindernis 3

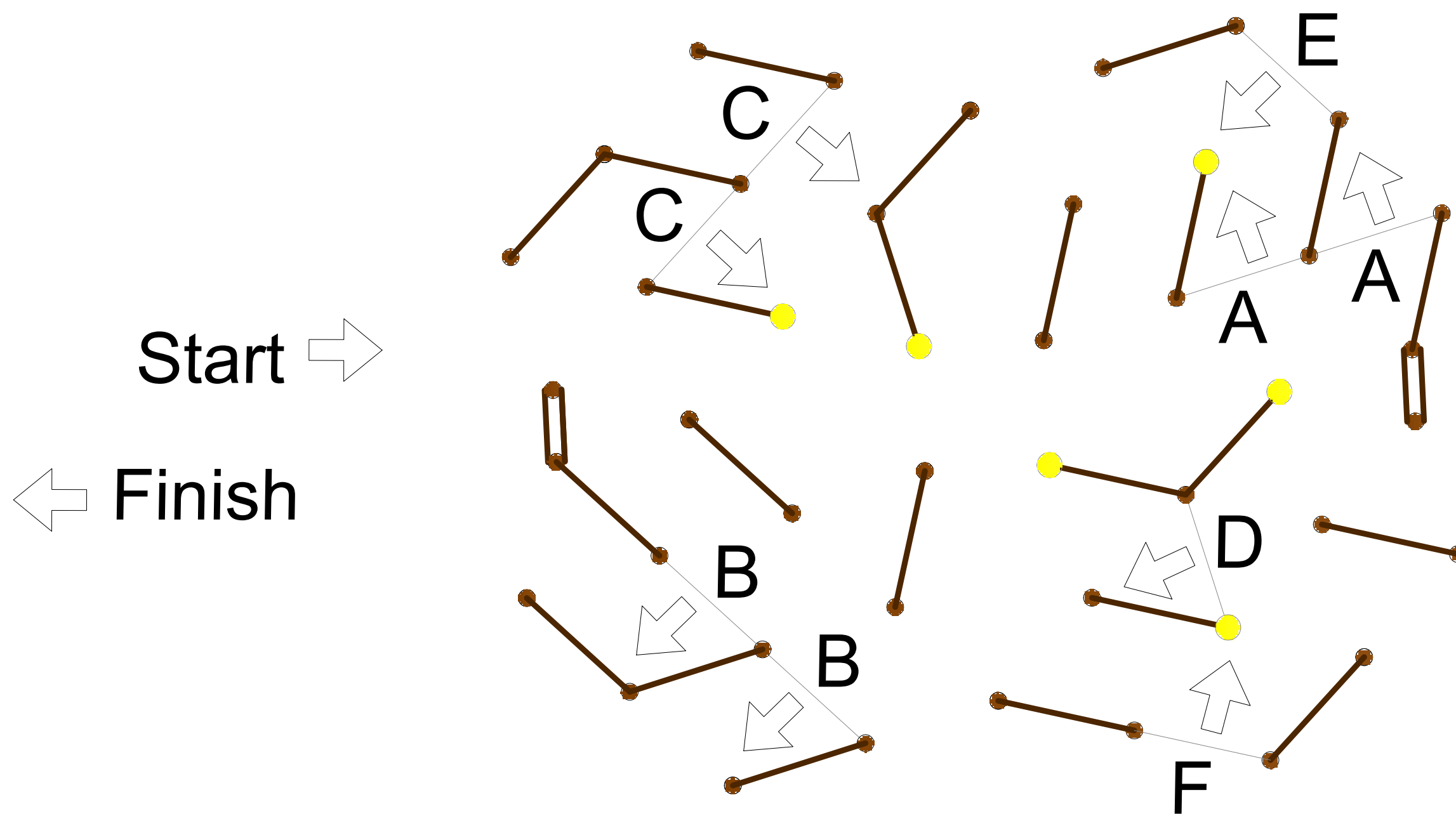

CAN** Hind 3 abcdef
CAN * Hind 3 abcde
jun & ch Hind 3 abcde

● 6 X knock down

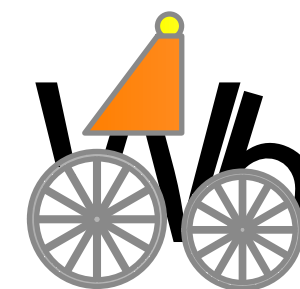

CAN BOOISCHOT 2016

Hindernis 4

Start ↙

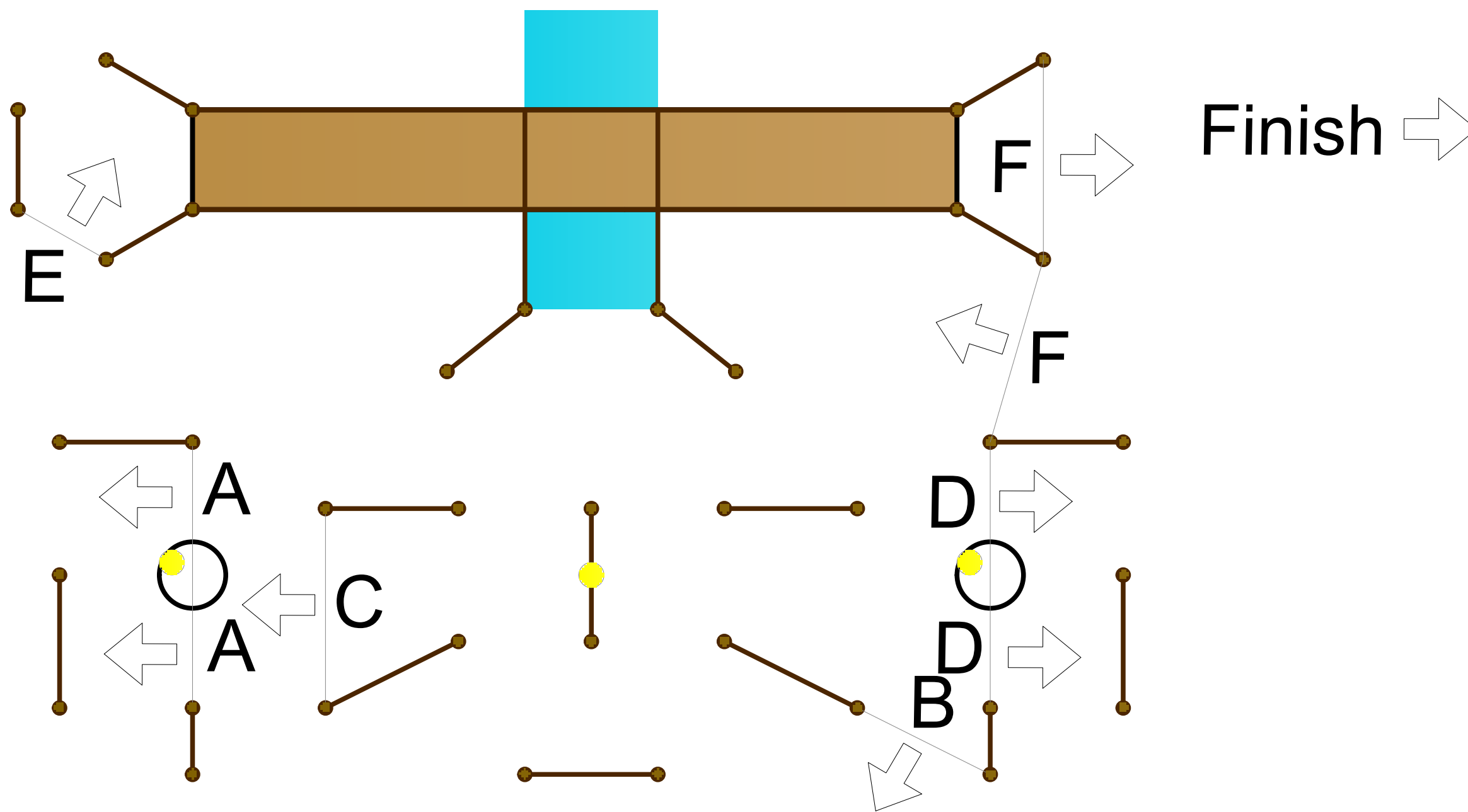

CAN ** Hind 4 abcdef
CAN * Hind 4 abcde

● 3 X knock down



CAN BOOISCHOT 2016

Hindernis 5

Start →

← Finish

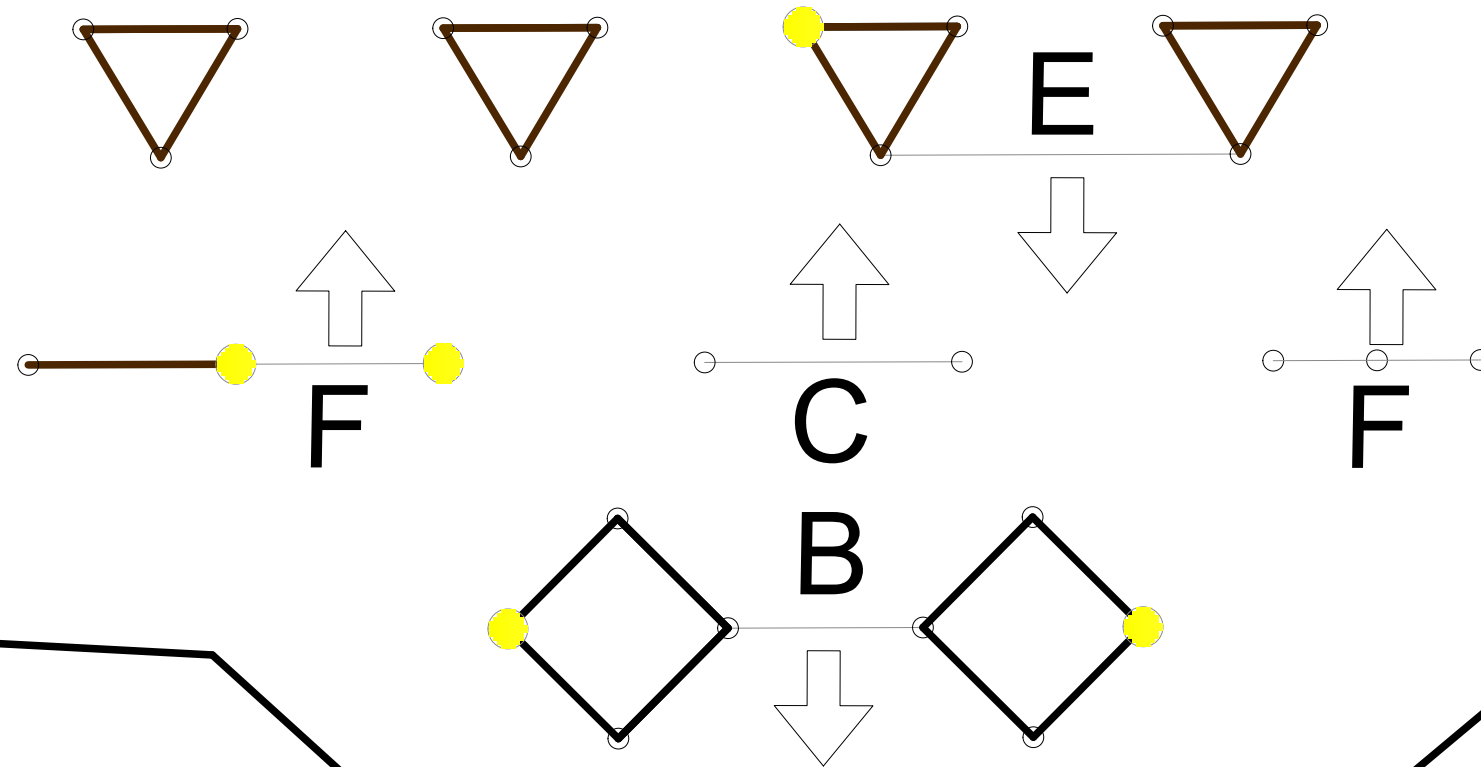
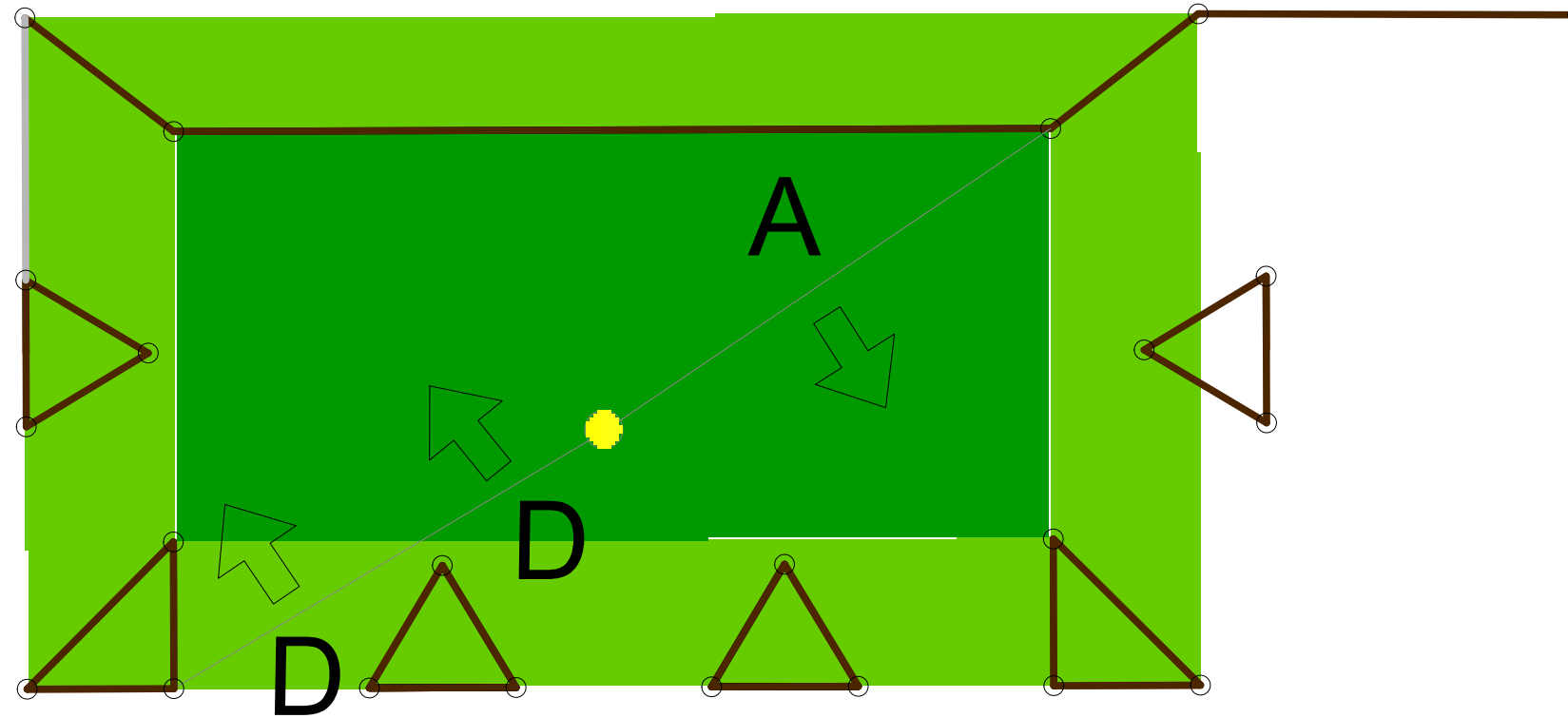

CAN ** Hind 5 abcdef
CAN * Hind 5 abcde

● 6 X knock down



CAN BOOISCHOT 2016

Hindernis 6

Start →

← Finish

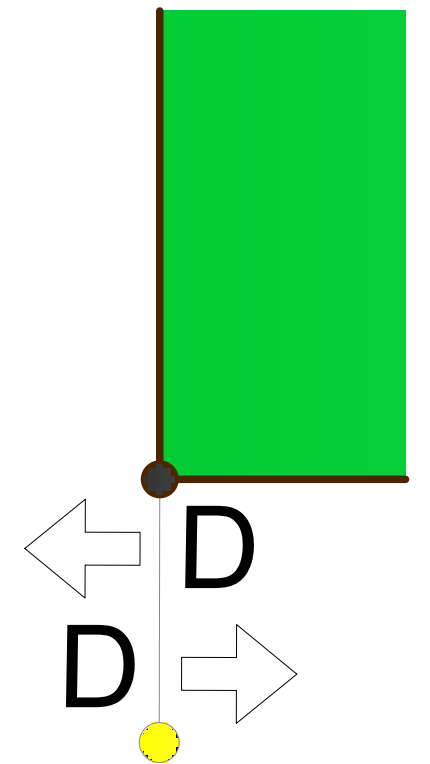
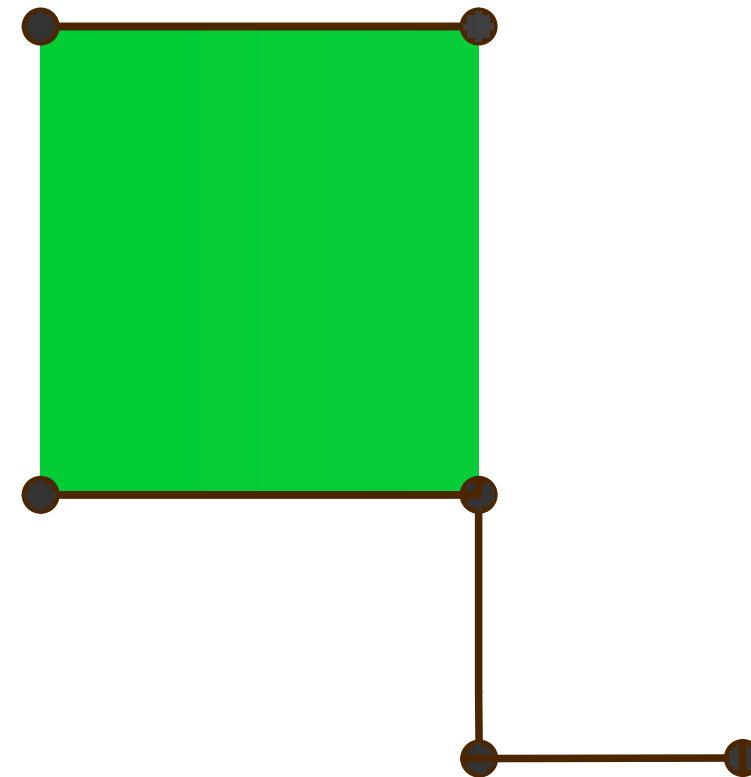
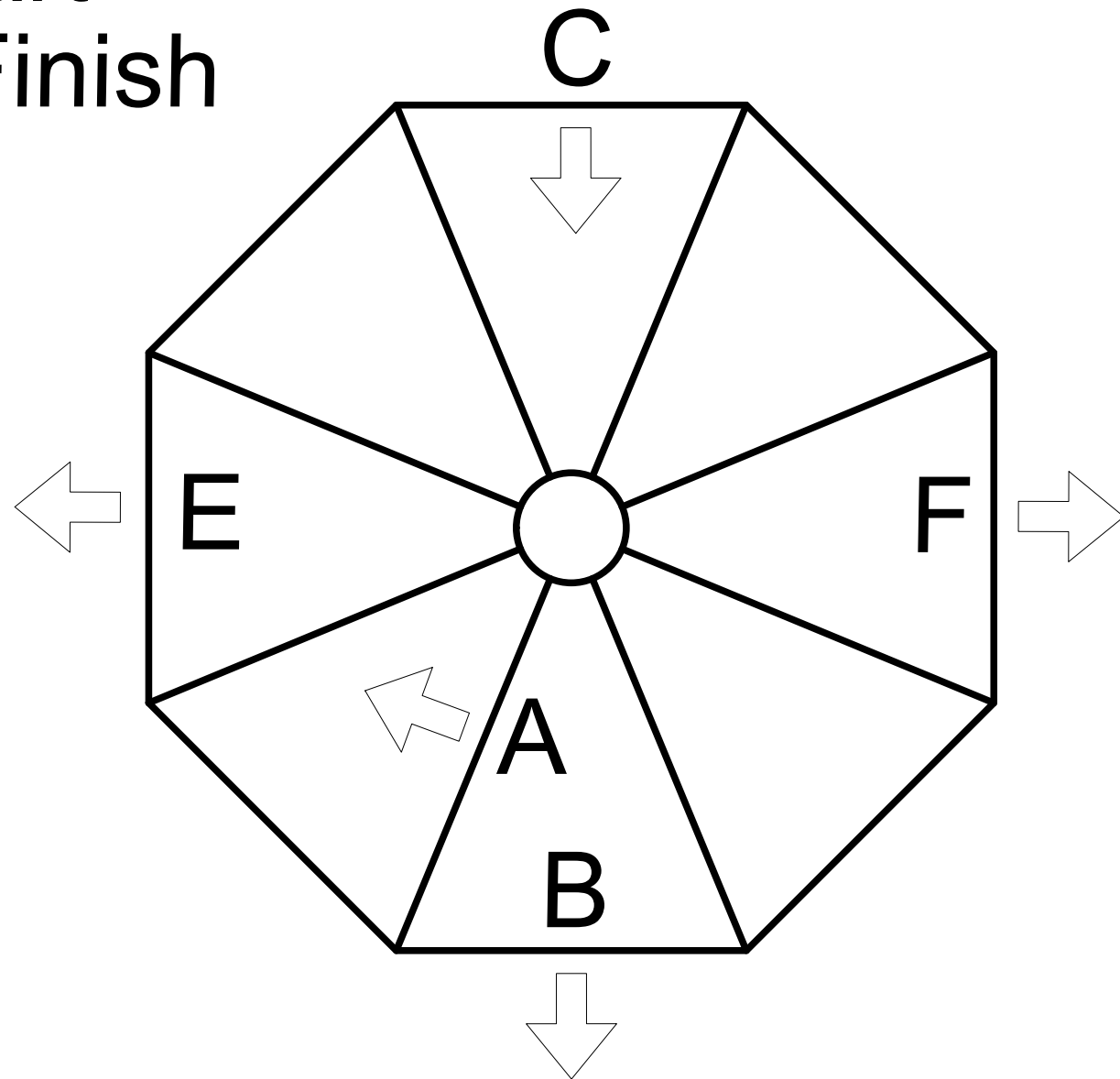

CAN ** Hind 6 abcdef
jun & ch Hind 6 abcde

● 1 X knock down



CAN BOOISCHOT 2016

Hindernis 7

Start →

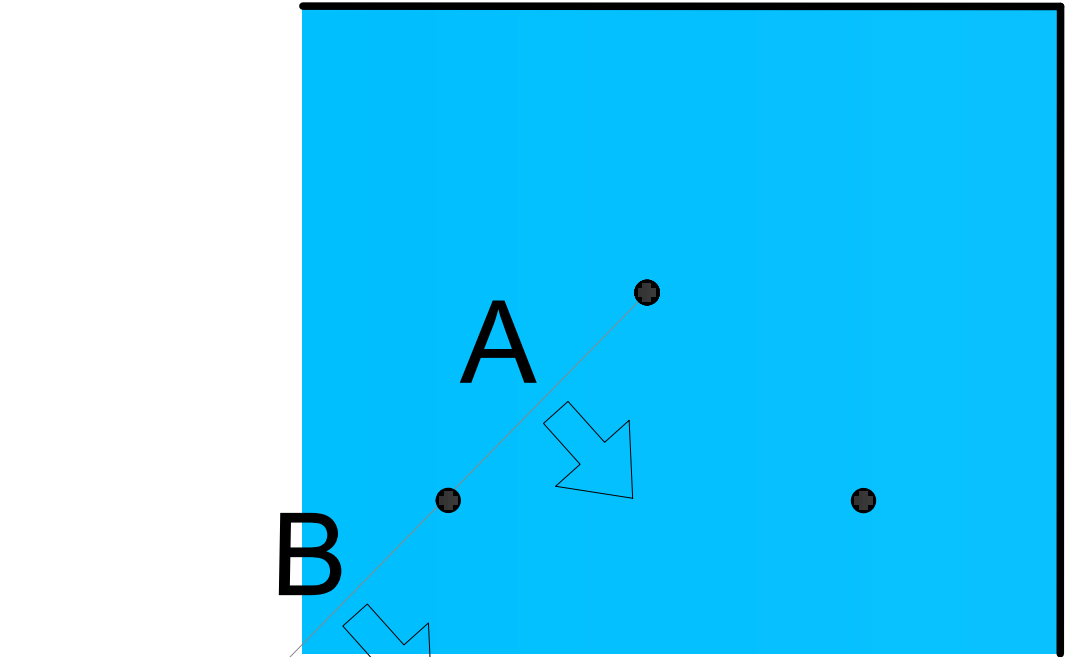
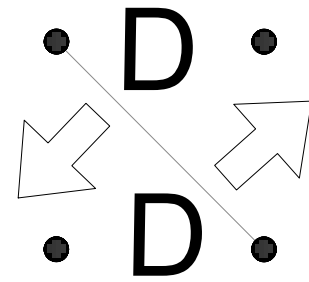

B



E

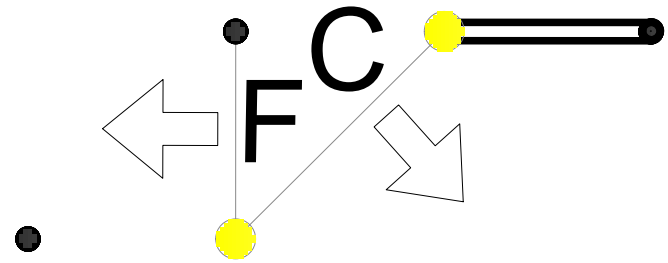

C

F

- CAN ** Hind 7 abcdef
- CAN * Hind 7 abcde
- jun & ch Hind 7 abcde



Finish

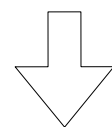

● 4 X knock down

CAN BOOISCHOT 2016

Vaardigheid

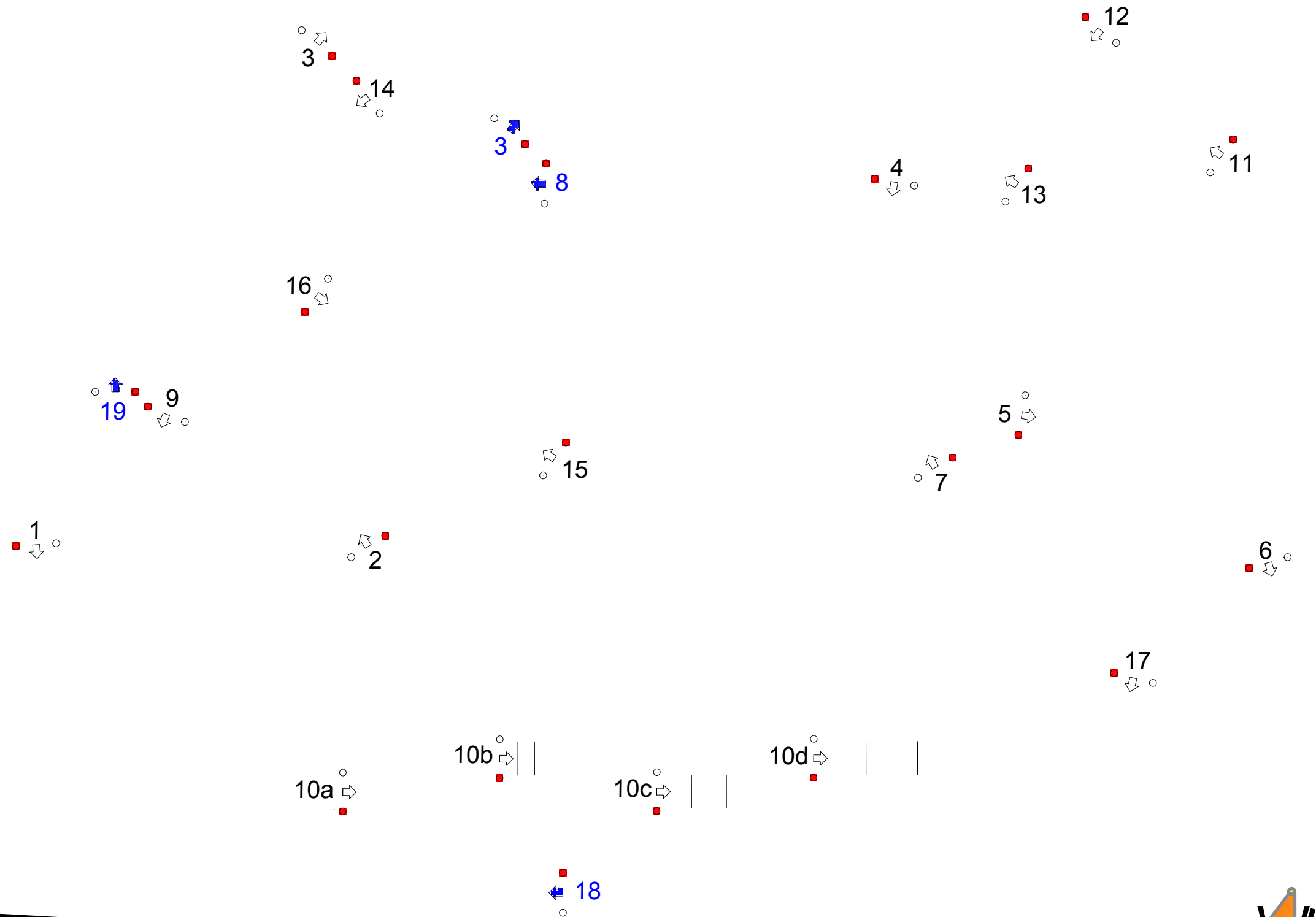
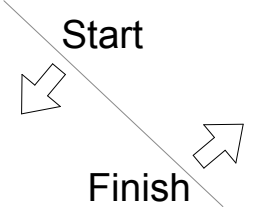

Raodbook B trajet CAN**

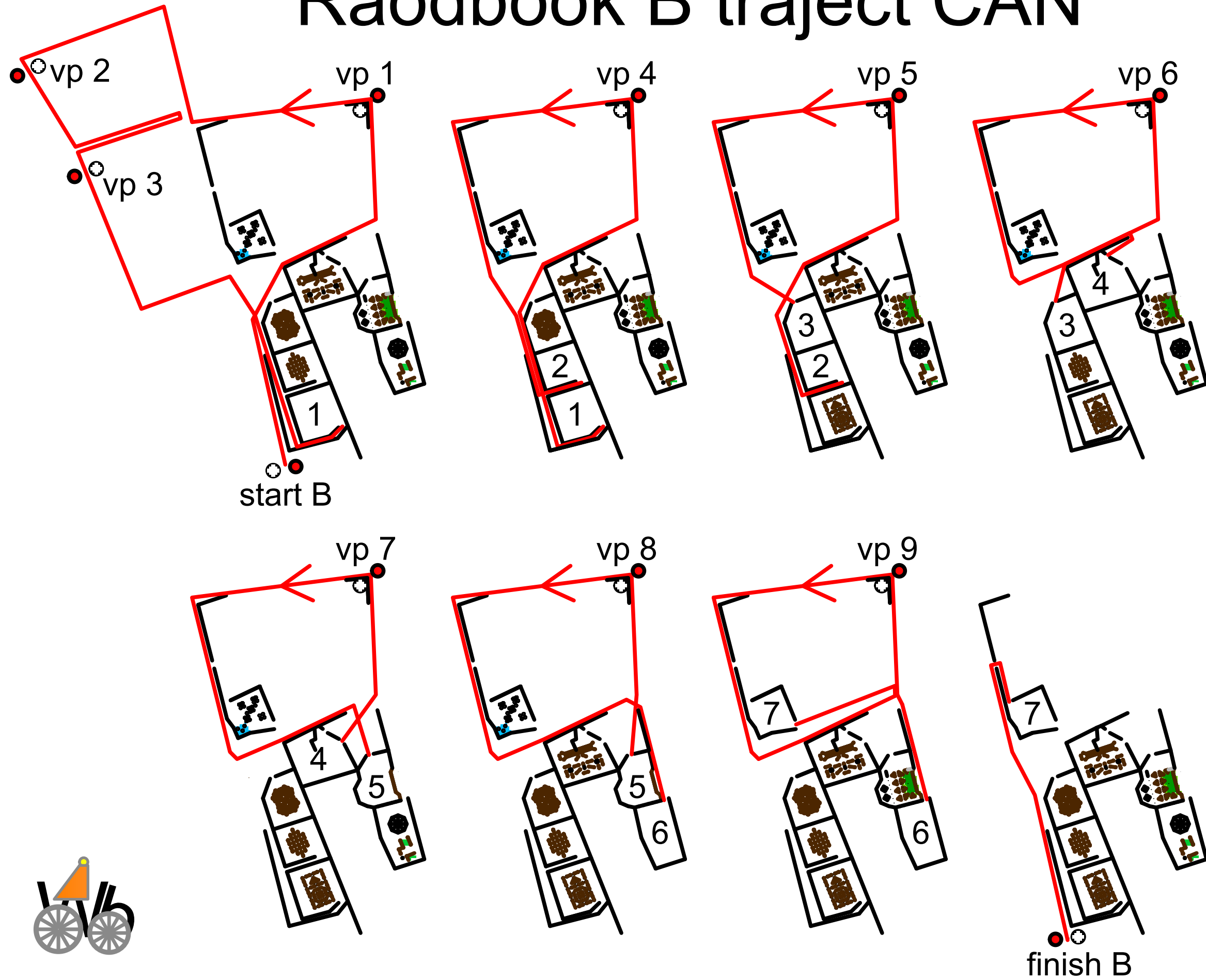

Raodbook B trajet CAN*

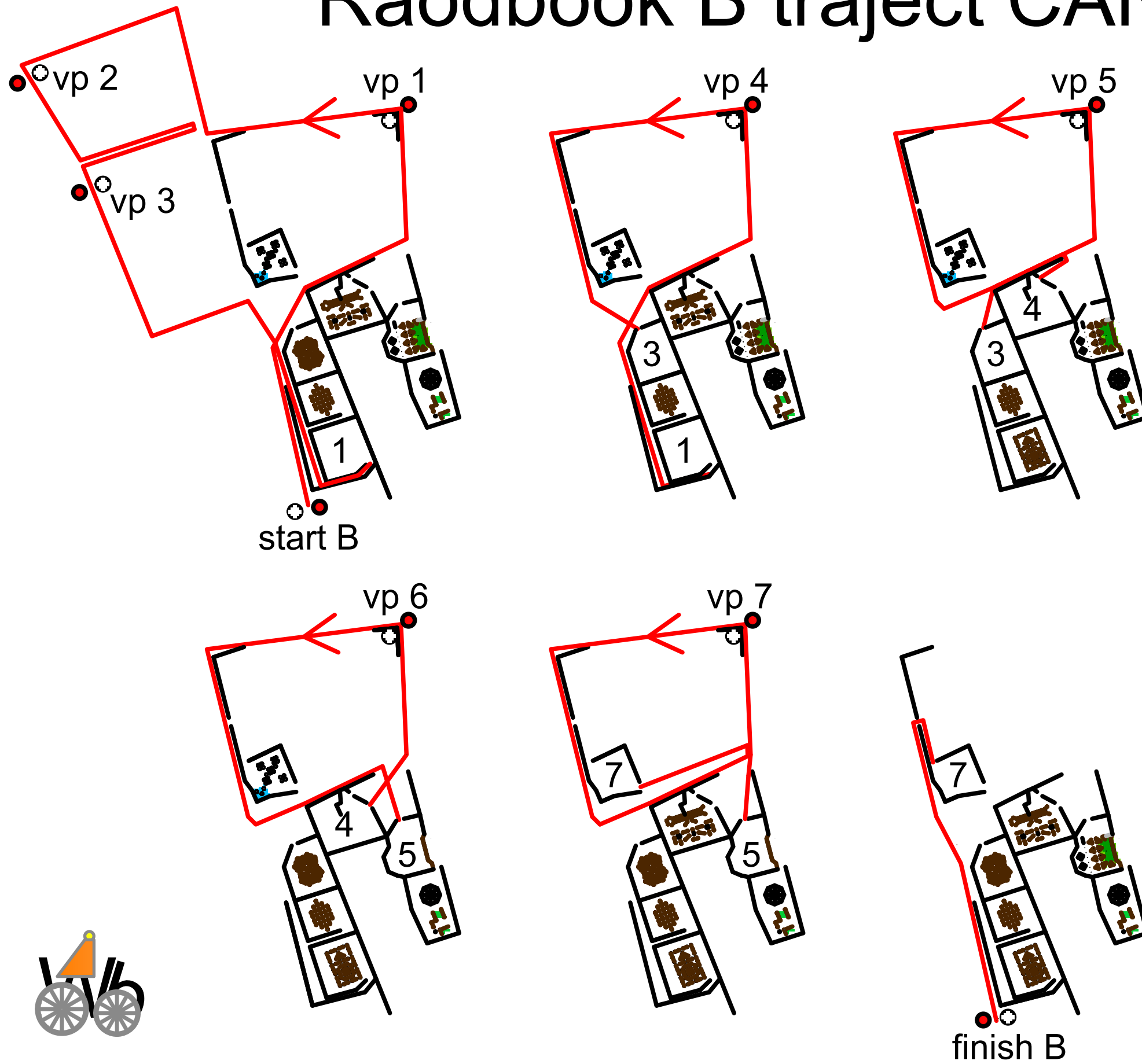

Raodbook B traject Child & jun

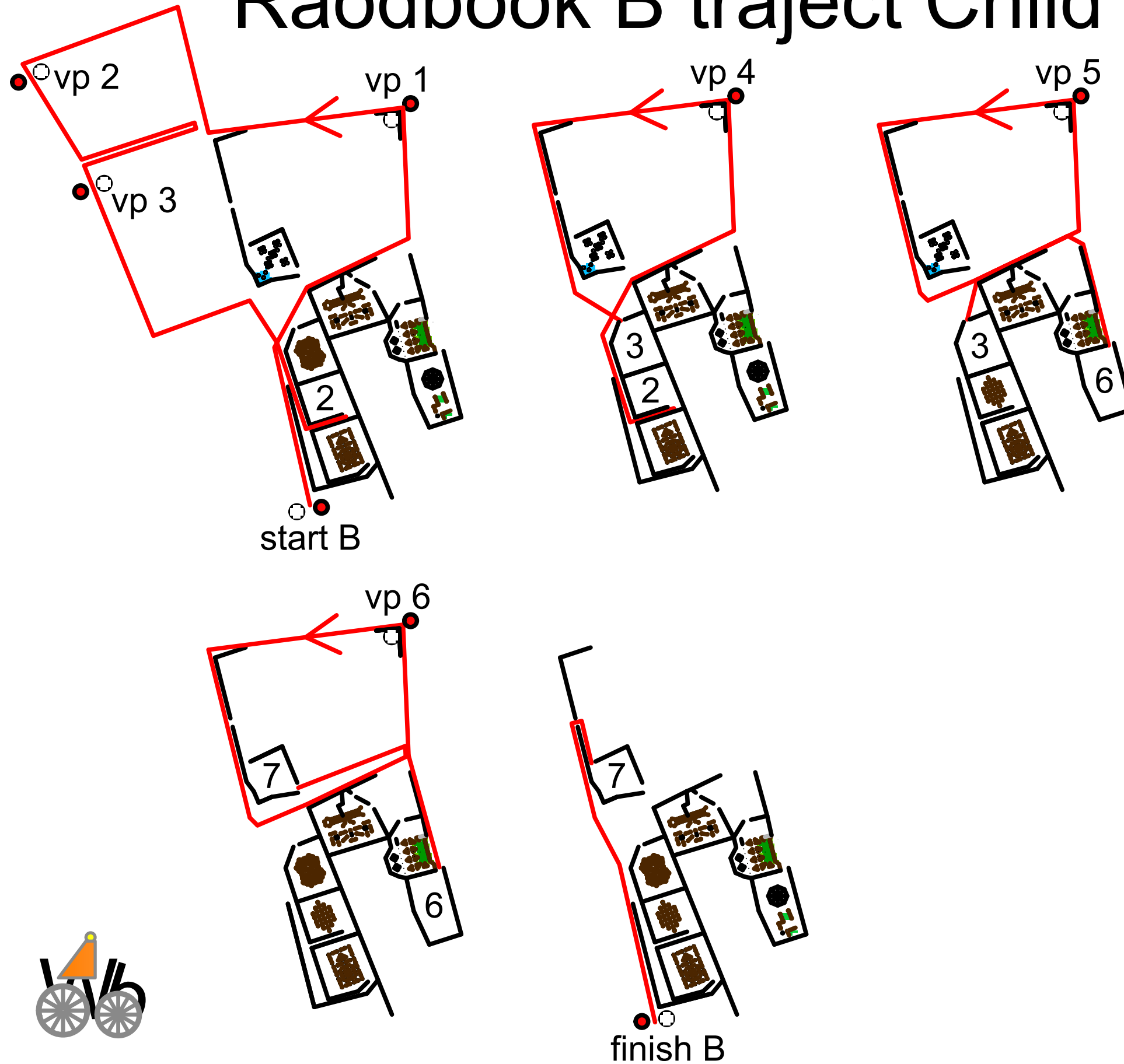

CAN BOOISCHOT 2016

A traject



CAN BOOISCHOT 2016

Derby Benjamins

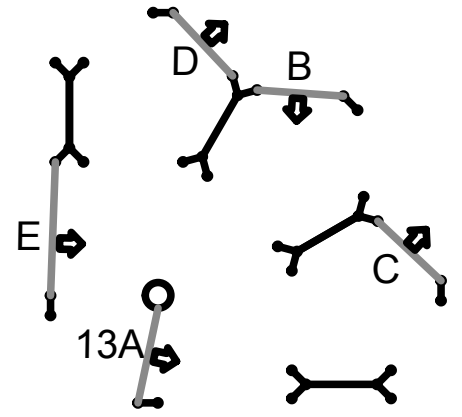
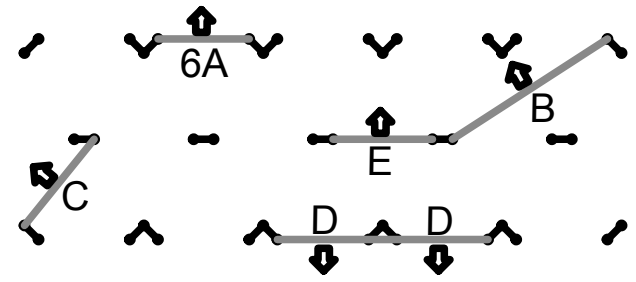
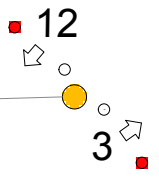
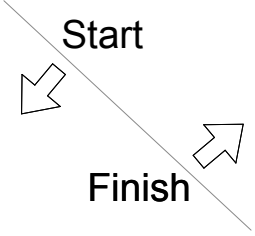

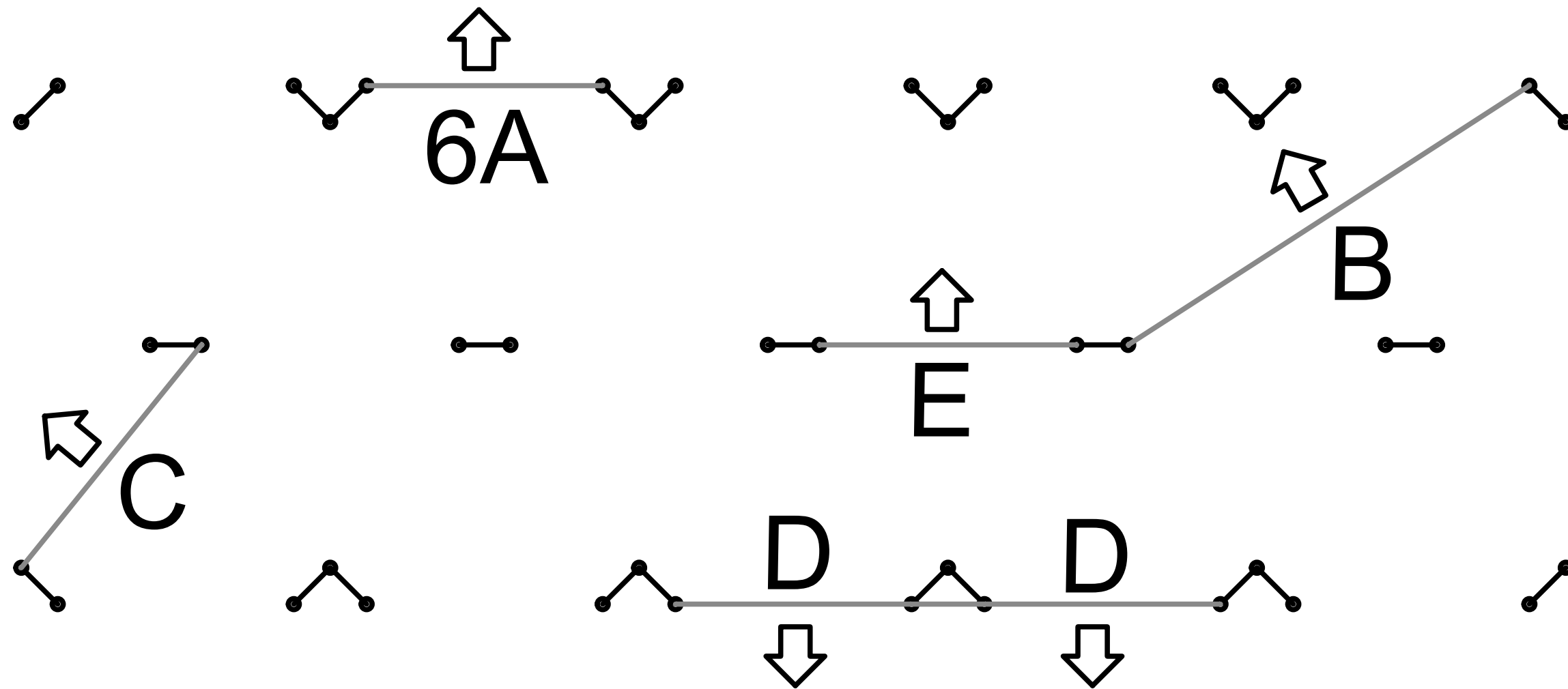

CAN BOOISCHOT 2016 Derby Benjamins hindernis 2

